

Article number: 0102212

Description: Retaining ring J370 DIN472  
Spring steel

## Measures

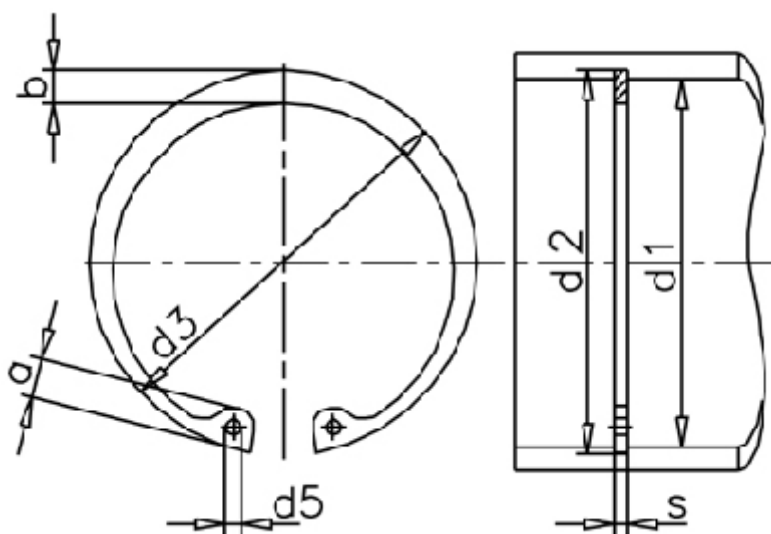

a max	=	FN kN	= 981.00	t	= 5.00
AN mm <sup>2</sup>	= 5890.0	FRg kN	= 95.0	tol	= +0,89
b	= 20.0	FR kN	= 803.0	tol	= +2,00-0,90
d1	= 370	g	= 5.0	tol	= -0.15
d2	= 380.0	K kN-mm	= 1839.0	Tong	= ZGJ-5
d3	= 387.00	m min	= 6.20	Weight kg/1000	= 920.00
d5 min	= 6.0	Nominal drive	= 15.0		
Description = J 370		s	= 6.00		